



# PANELIFT® / PANELIFT ICON™ SINGLE & DOUBLE END STILE QUICK CLOSER INSTALLATION INSTRUCTIONS

Part No. SD0002

## INSTALLATION INSTRUCTIONS FOR SINGLE END STILE SD0003 AND DOUBLE END STILE SD0004 WITH BRACE PLATES ON SMALL RADIUS CURVE

### FIGURE 1

Headroom = from top of door to top of:

- Spring anchor combo bracket, headroom = 180mm (min).
- Cable drum (centre spring anchor bracket and side end bearing brackets) headroom = 175mm (min).

Vertical track length = Small curve door height - 235mm  
= Large curve door height - 255mm

### FIGURE 2

Install the brace plate on top corners of the top panel, locate the plate over the 2 stile screws. Fasten the brace plate with 4 off tek screws.

*For a double end stile door install the second brace plate in same position on 2nd stile) FIGURE 6.*

### FIGURE 3 - Single End Stile

Assemble the quick closer with 2 wheels and axles fitted to 'back 2 holes'

With door in closed position, attach the lower hinge plate of the quick closer to the brace plate, ensure the two wheels are sitting on the bottom of the track.

*For a double end stile door use 2 quick closers on each side and 2 long axle wheel.*

### FIGURE 4

Fasten the quick closer lower hinge plate to the brace plate, with 2 tek screws.

**NOTE:** For additional strength on single end stile doors, as shown, drill a 5.5mm hole through the quick closer and brace plate and fix with a tek screw as shown.

### FIGURE 5

For optimal drive through clearance cut the hockey stick and fit as shown. **NOTE:** Reinforcing may reduce the walk under clearance by 65mm

Follow standard installation procedures.

**RECOMMENDATION:** For optimal walk in clearance an opener is required to lift door curtain to fully open position. The hockey stick connection to the top panel: position the pivot point  $\perp$  at the top of the panel, or as near as practical to the centre line of the quick closer's pivot point.

### FIGURE 6

Double end stile quick closer installation Part SD0004.

FIGURE 1

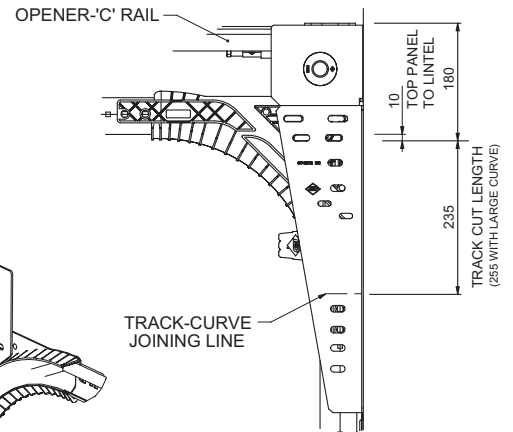

FIGURE 2

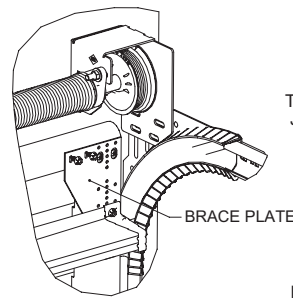

FIGURE 3

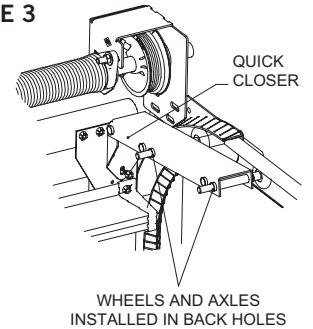

FIGURE 4

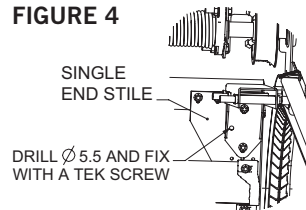
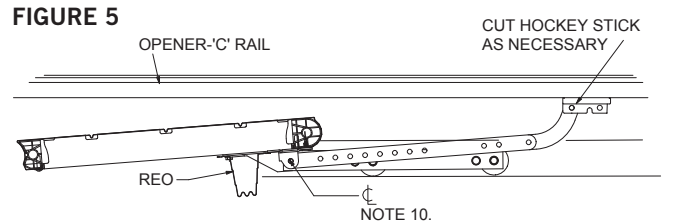
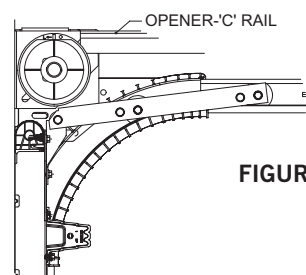

FIGURE 5



SIDE VIEW  
DOUBLE END STILE  
QUICK CLOSER



DOUBLE END STILE  
QUICK CLOSER

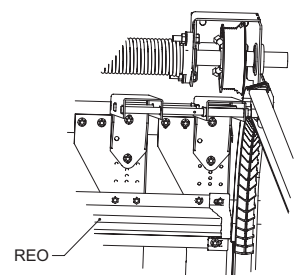

## DISCLAIMER

THESE INSTRUCTIONS ARE INTENDED FOR PROFESSIONAL GARAGE DOOR INSTALLERS  
and only apply to the fittings

Note: All references are taken from inside looking out

